



### DESIGN HIGHLIGHTS

- Full Cable Management Trunking
- Easy Installation / Mounting
- Removable Front Cover
- Reversible Locking Vented Door

### OPTIONS

- 3 Standard Size Options  
C4E5 - 5 MODULES  
C4E7 - 7 MODULES  
C4E9 - 9 MODULES

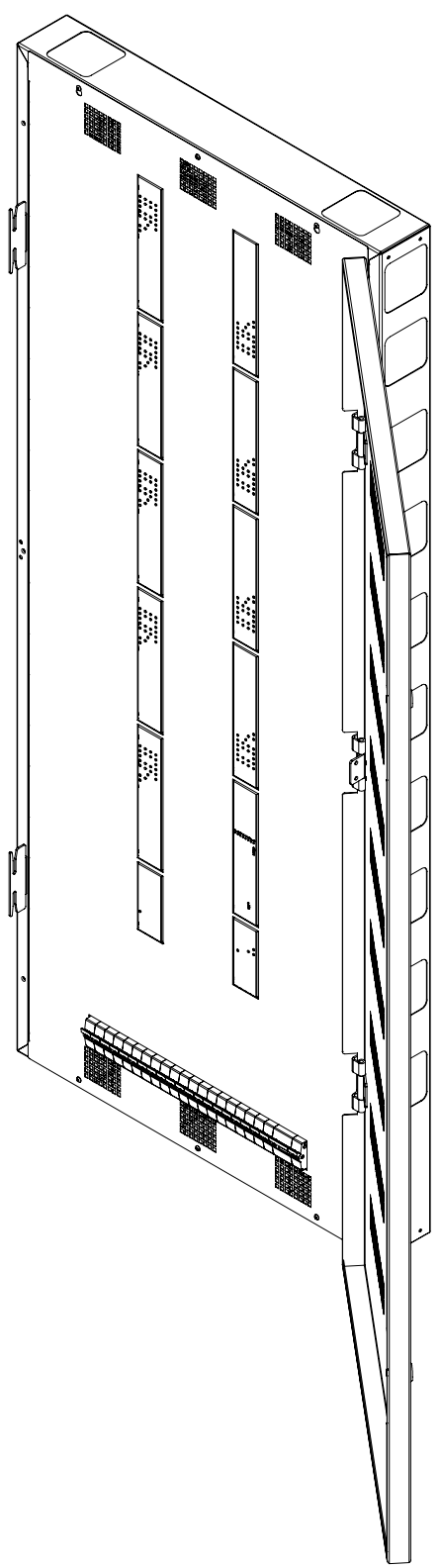
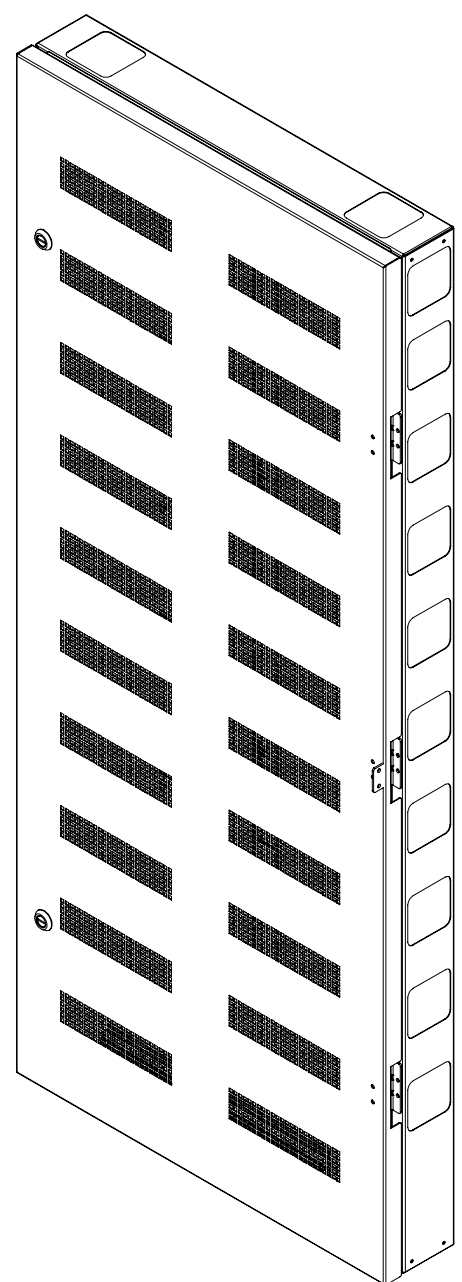

## ENCLOSURE DIMENSIONS

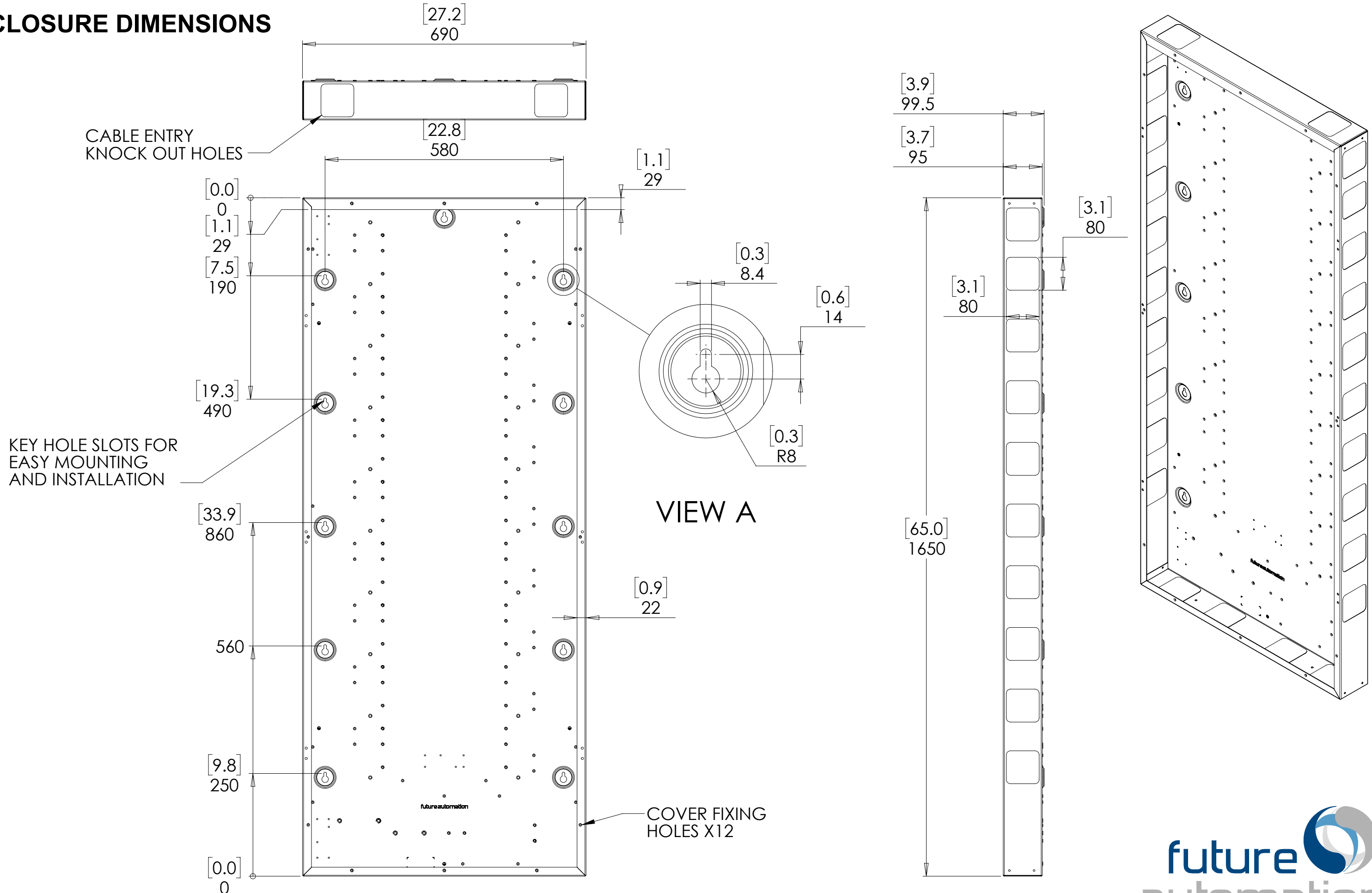

## OVERALL DIMENSIONS

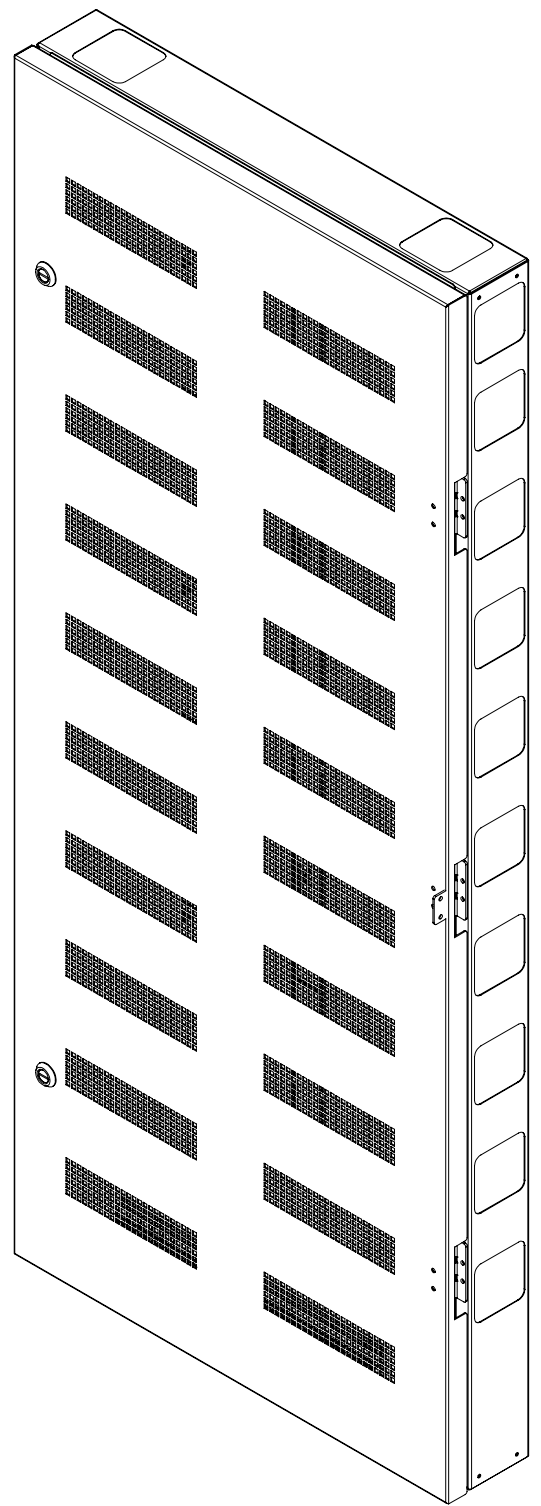
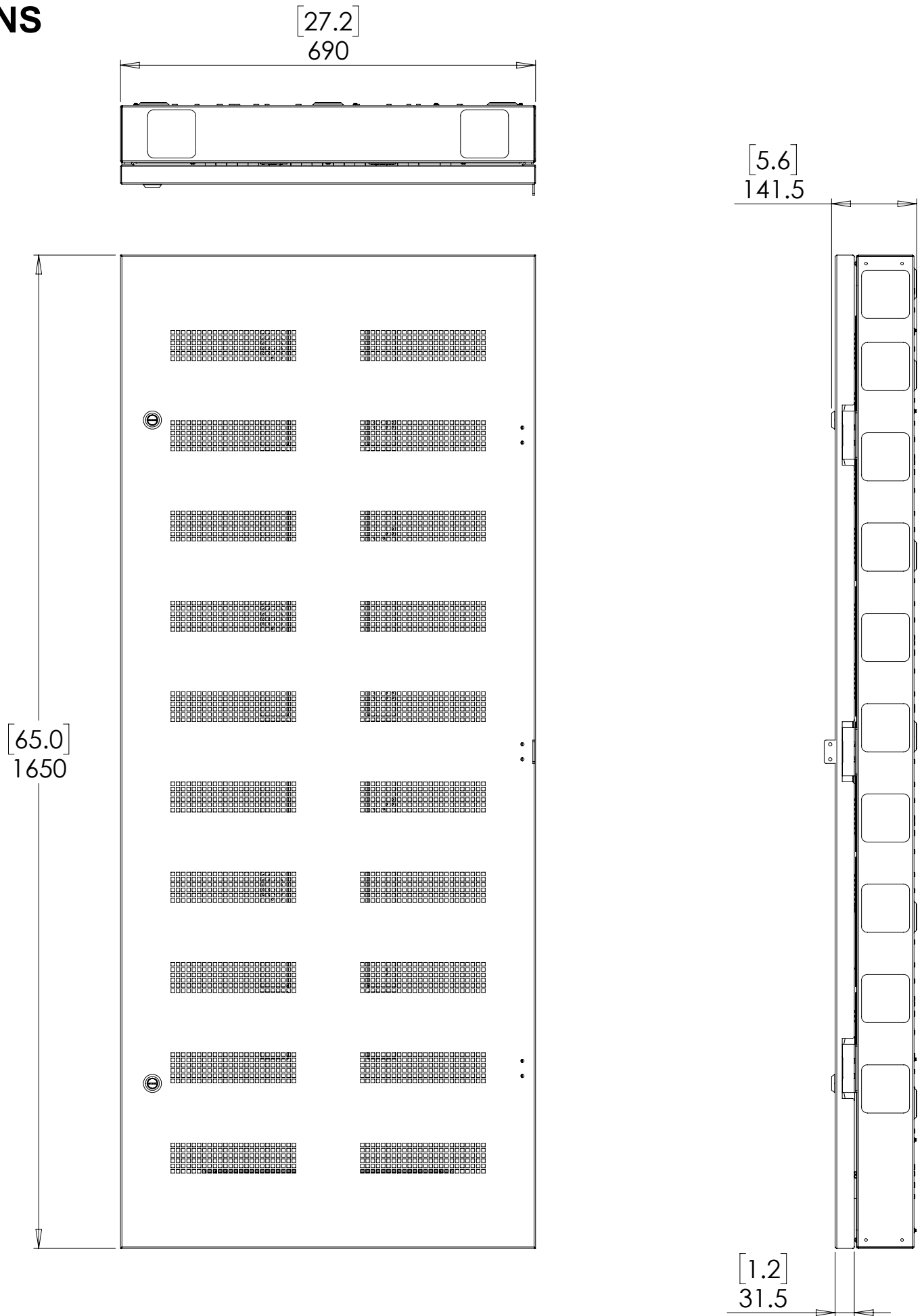

## REVERSIBLE DOOR OVERVIEW

Door shown opening towards the right hand side

In order to switch to left hand side opening, simply remove front cover panel and swap latch brackets and hinge outers over

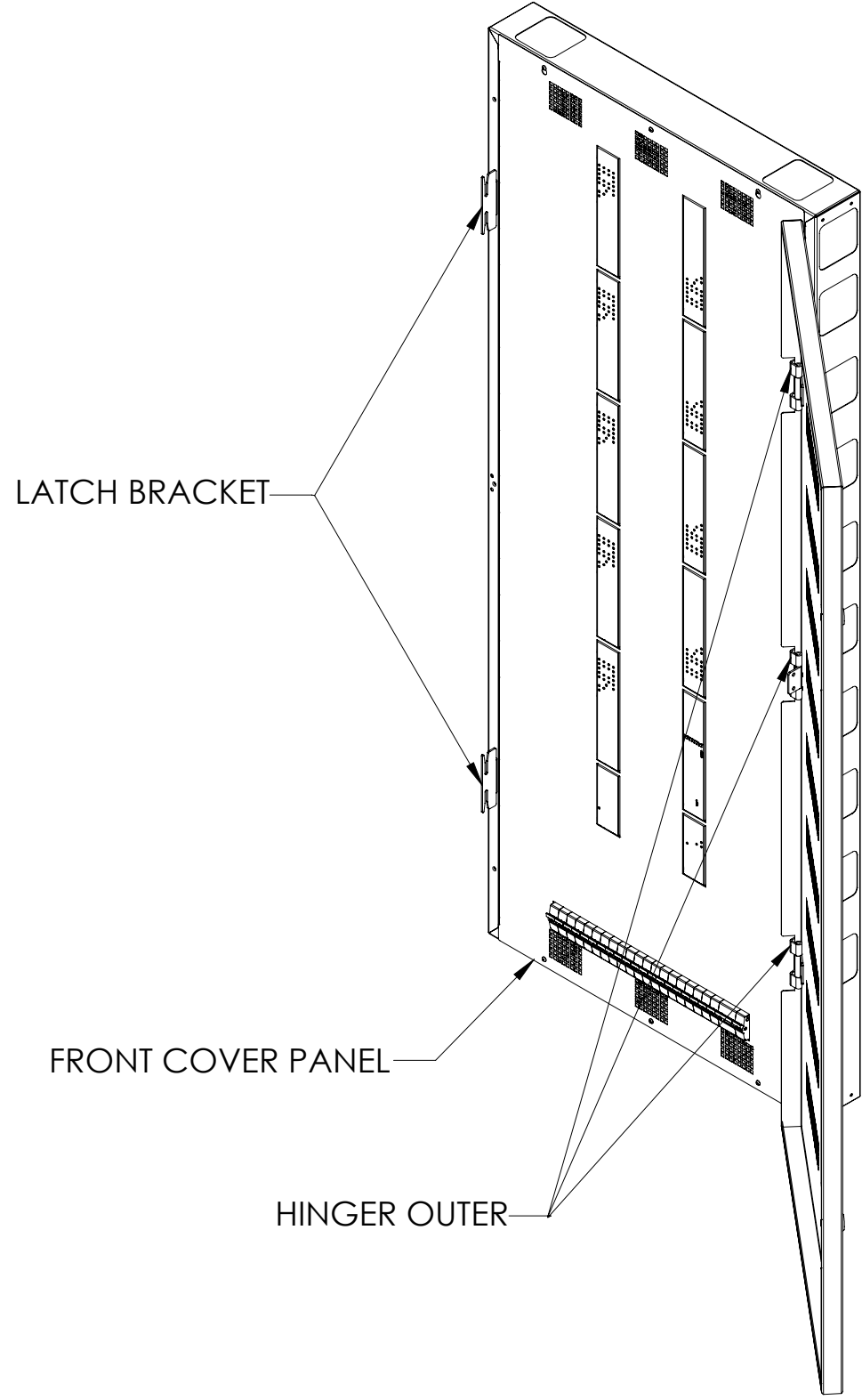

## PANEL BOX LAYOUT

Exploded View

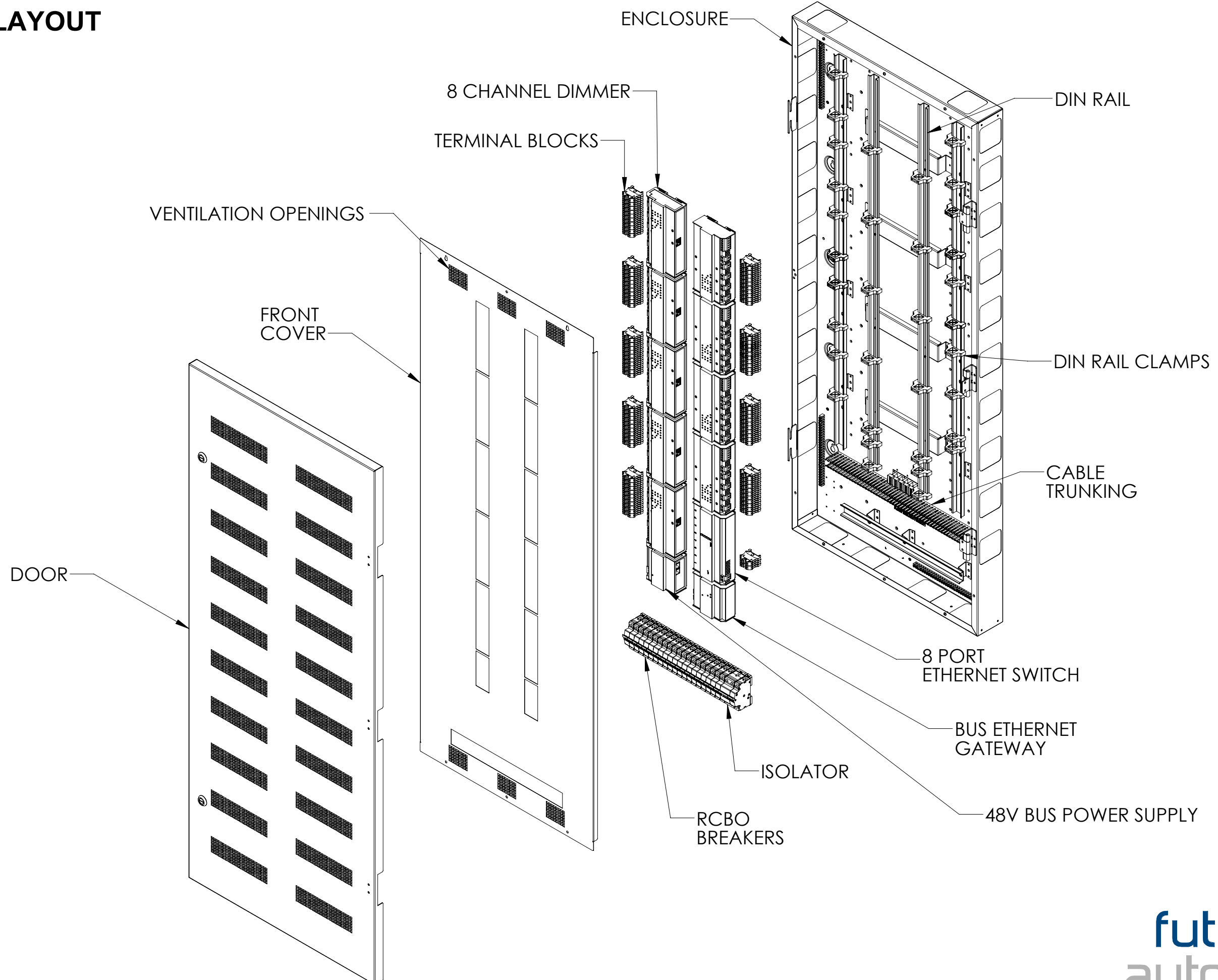

## PANEL BOX LAYOUT

Front cover removed

